

2024 SPRING | COMPANY BUSINESS CATALOGUE

# SUPrema

SECURITY & BIOMETRICS

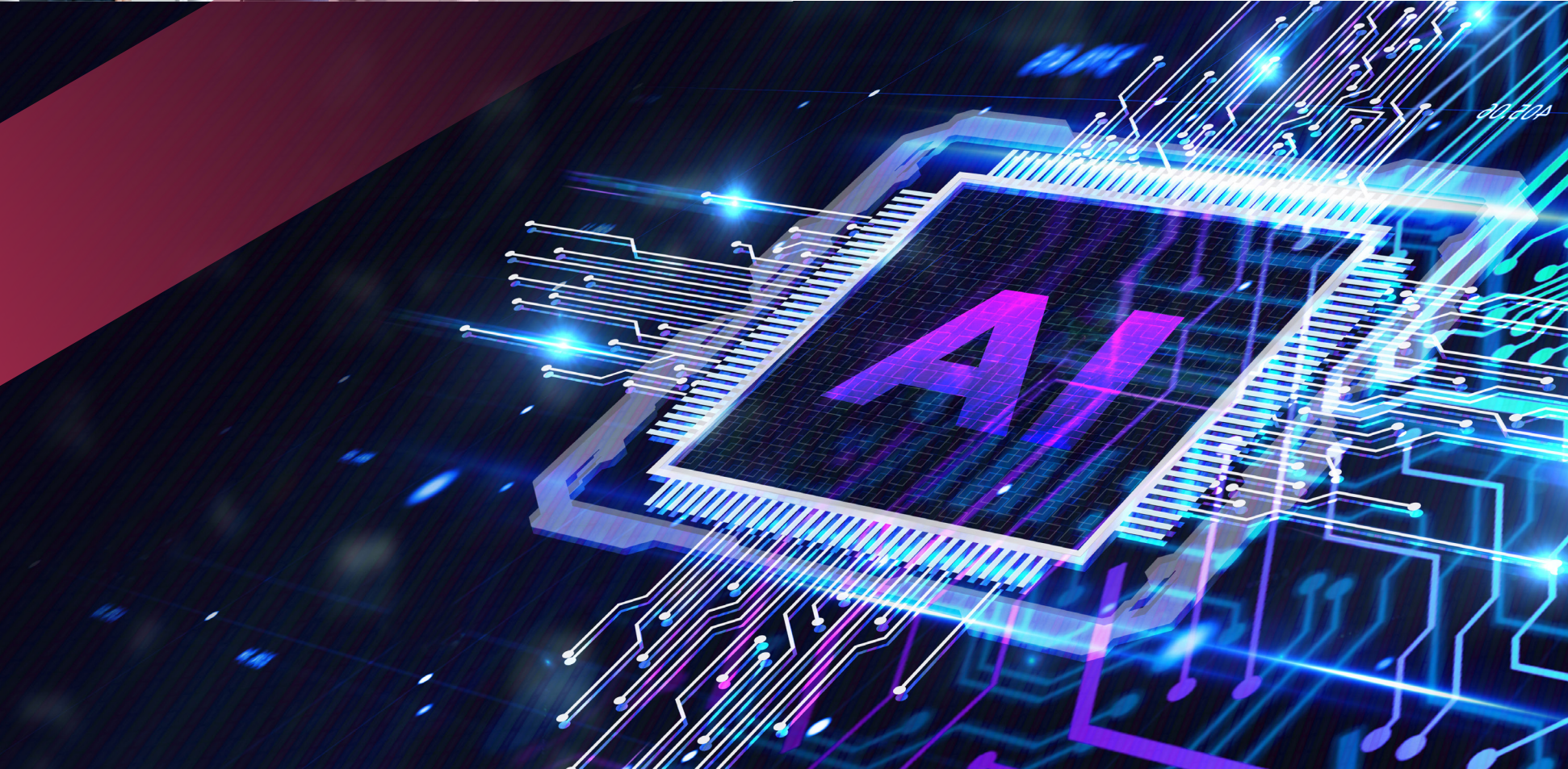

# Contents





BioStar 2		08p
Controller		16p
RFID Reader		18p
Mobile		20p
Biometrics		24p
Fingerprint Modules		26p
Development Tools		27p
Product Data Sheet		28p

To become a leading provider of  
Access Control Solutions with  
innovative products and services





Established in 2000, Suprema Inc. is a global leader in AI-based security solutions. Over the past two decades, Suprema has demonstrated its expertise and technical superiority in AI security and biometric authentication. Suprema has led groundbreaking innovations in the industry, introducing an integrated security platform, deep-learning based AI solutions, biometric access control systems, cloud solutions, mobile access solutions, and embedded fingerprint modules.

Suprema serves diverse clients across government organizations, banks, hospitals, schools, manufacturing factories, and construction sectors. From startups, mid-sized to enterprise-level businesses, Suprema offers customized solutions and services to meet varying security needs.

With a presence in over 140 countries, Suprema has established itself as a premium global brand. Suprema is recognized among the world's top 50 security manufacturers and holds the top market share in biometric access control across Europe, Middle East, and Africa region.



Year Established

**2000**



Security Manufacturer

**Top 50**

(A&S Magazine, 2011-2023,  
13 years in a row)



EMEA Market Share

**No.1**

in Biometric Access Control  
(IHS Markit)



Number of people using  
Suprema technologies

**1 Billion +**



Systems  
in Operation

**1.5 Million +**

(worldwide installations)



Global Sales  
Network in

**140 Countries**



National Identification  
Projects in

**23 Countries**



Industry Patents and  
Intellectual Properties

**100+**



Excellent Financial  
Stability

**A+**

(Korea Investors Service)









# | BioStar 2

Powerful, Friendly, Secure,  
Open Integrated Security Platform

Discover BioStar 2, your robust security platform with advanced features and an open architecture. Effortless but powerful, BioStar 2 makes multi-credential authentication easy and works the way you need to secure your business.

Start Simply,  
Grow Endlessly:  
Scalable and Flexible Architecture

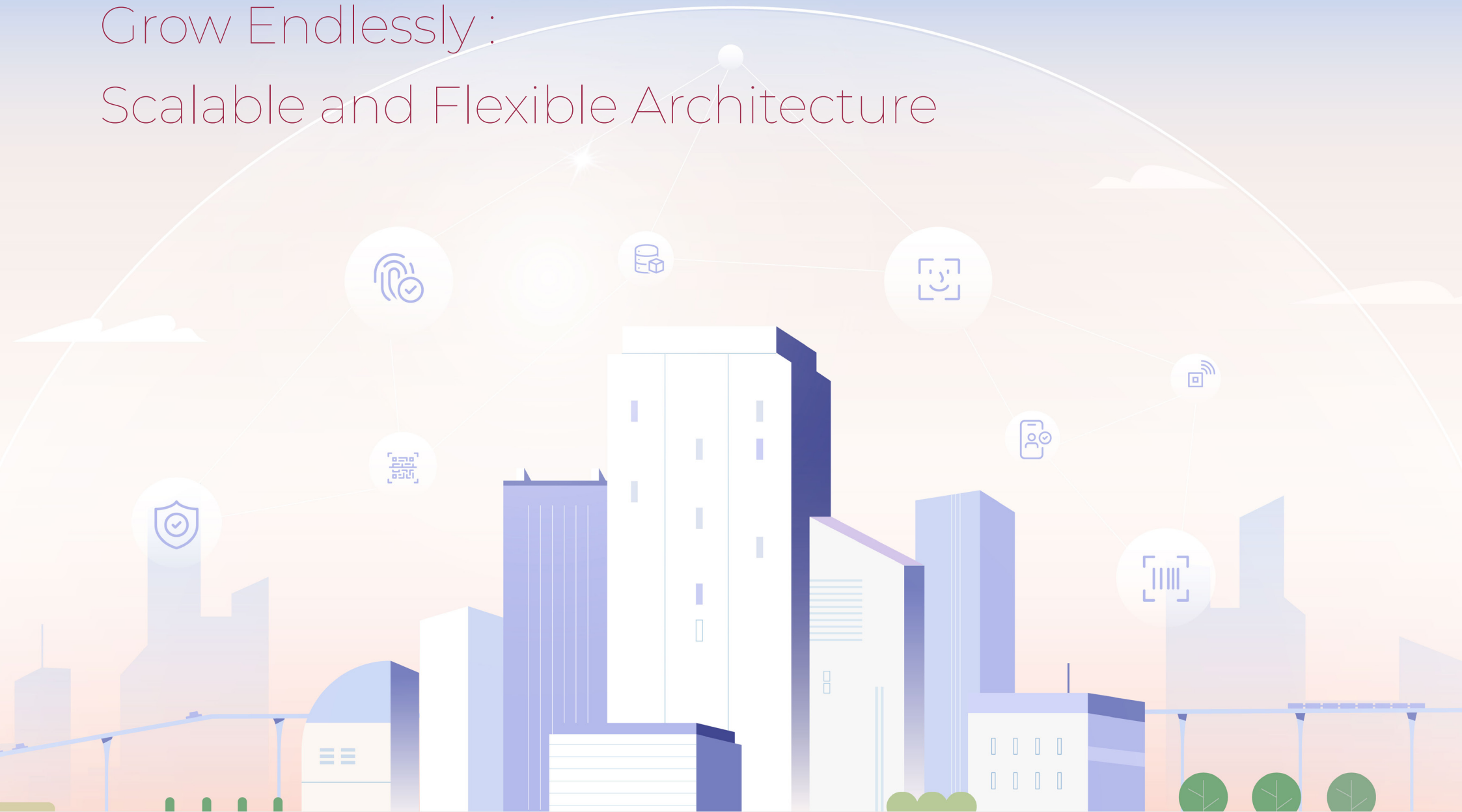

# BioStar 2 Access Control

With the purchase of BioStar 2 AC license, you can use advanced access control features like elevator control, advanced anti-passback zone control, fire alarm zone, scheduled lock/unlock zone, intrusion alarm zone, server matching, and video log features.

-  Customized System Architecture
-  Elevator Control
-  Improved Zone Management
-  Server Matching
-  Video Logs
-  Visitor Management



## BioStar 2, Certified for Data Protection

Suprema BioStar 2 platform and access control devices are certified by ISO for data protection measures and are GDPR and CCPA compliant, meeting all of 26 data protection management standards, 114 data protection control and 18 personal information management requirements.

All personal information stored in Suprema products, including biometric data, are encrypted using AES algorithm and the encryption keys are safely managed in cryptochips(SecureElement), with access routes securely blocked.



# Access Controllers

Suprema's intelligent controller (CoreStation) manages all devices and readers, keeping your site as well as personal information secure and compliant.



## Easy to Manage

Access control, decision-making, and data management are centralized at a single point



## Enhanced Security

Sensitive data are stored in main controllers with a Secure Element, ensuring protection from unauthorized access



## Easy to Scale

Simplify expansion by adding capacity easily while keeping costs under control

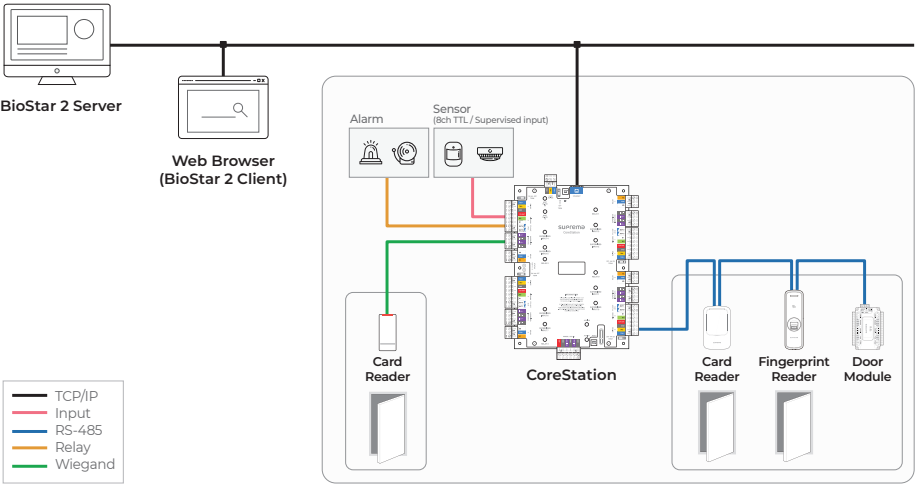

Centralized Access Control Systems

# Intelligent Reader Devices

Intelligent network device can serve as both a controller and a card reader simultaneously, suitable for companies that need flexibility for installation and maintenance or want to build their access control system in stages.



## Real-time Management

Intelligence at the network edge reduces response times and guards against connectivity loss



## Cost-Effectiveness

Simple wiring and low installation and maintenance costs for new installations or upgrades from legacy systems



## Flexible Adaptation

Add, remove, upgrade readers and devices without system-wide impact

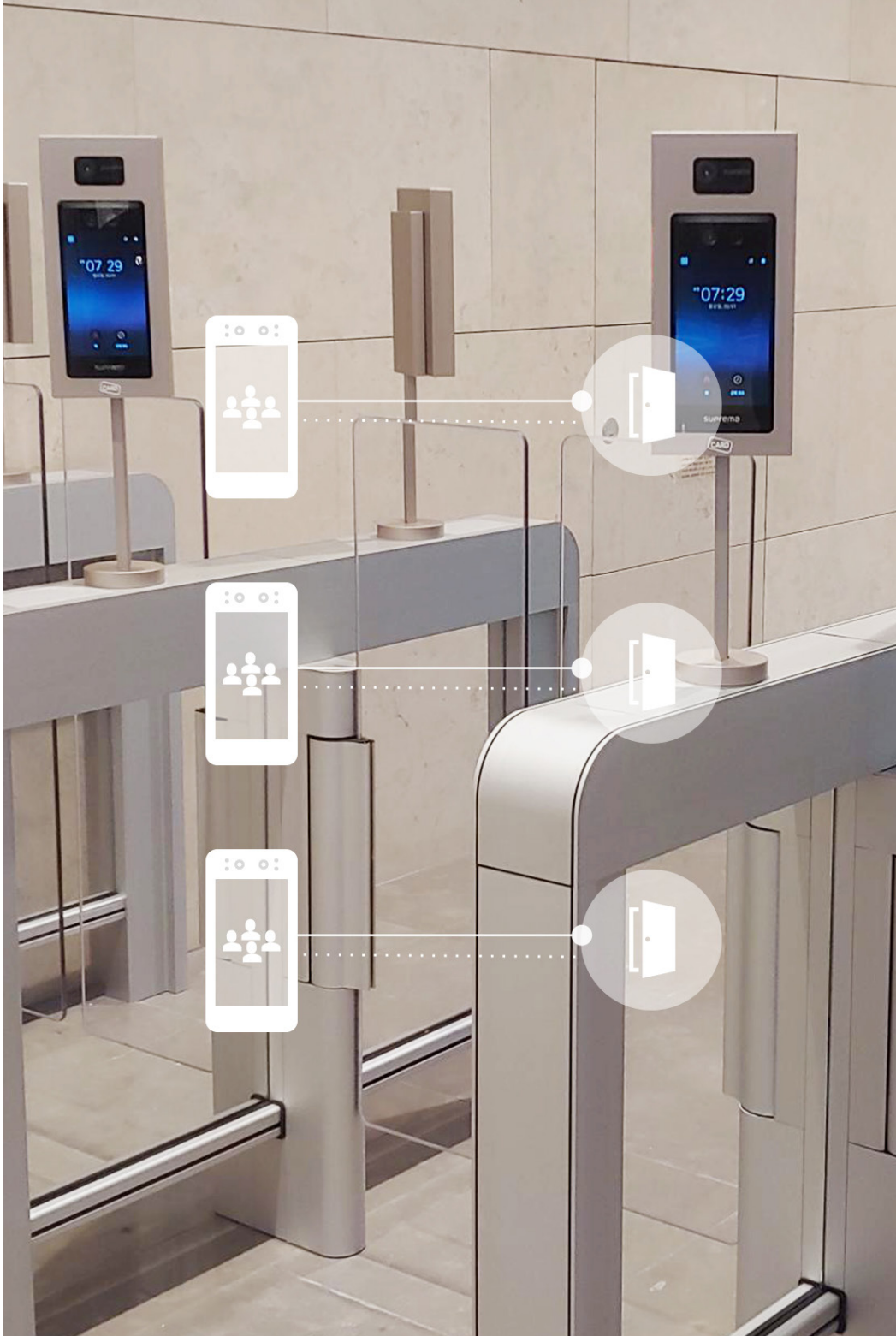
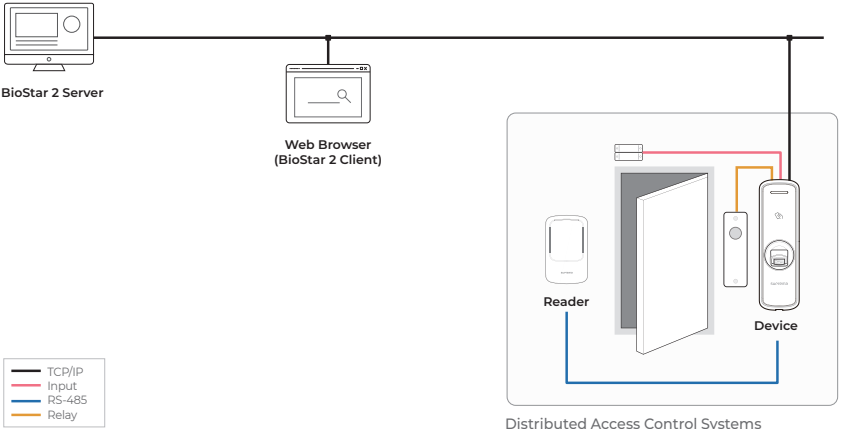

## Tailored User Experience with Multi-Credential Support

Not everybody has the same needs which is why BioStar 2 natively supports a wide variety of credentials. Effortlessly issue physical cards, mobile credentials or biometric authentication according to your needs.



Facial Authentication



Mobile Access



Fingerprint Recognition



QR Codes



RFID Cards



## Effortless Management

Reduce learning time and start securing your site with the intuitive interface of BioStar 2. Managing access rights and administering system functions is a breeze with our user-friendly web-based platform.

## Full Featured Access Control

Benefit from advanced features that help your organization meet security, safety and compliance goals with full featured historical and forensic reporting, alarm and fire zone management, photo badging and powerful real-time monitoring. Expand further with Visitor Management and Time & Attendance options to eliminate the need for multiple systems.



### Enterprise-grade Software

Harness the power of robust enterprise capable hardware and software that guarantees uptime, compatibility with IT standards as well as providing interfaces to integration with diverse systems.



### Reliable Security Partner

Leverage the dedicated teams of Suprema who have been providing innovative solutions in security and identity for over 20 years.



### Open API Integration

Our open and secure API allows connection with all kinds of systems to streamline processes and automate tasks by allowing secure information transfer and system control.



### Cybersecurity

Certified with AES-256 , ISO 27001, ISO 27701, and protected with Secure Element(SE), Secure Boot, and data encryption.

# Controller

Suprema controller provides the advantages of a biometric-enabled security over a centralized access control system.



## CoreStation (CS-40) | Intelligent Biometric Controller

Designed to accommodate enterprise-level systems, Suprema CoreStation stores up to 500,000 users with an incredible fingerprint matching speed of up to 400,000 match per second. Its multi-port interface also supports nonbiometric access control system such as RFID card readers, door locks, alarms sensors and RTE. With its high-performance, biometric readiness and Ethernet communication, CoreStation lets users access the full features of the BioStar 2 platform. Suprema CoreStation can be used in conjunction with door modules and output extension modules to control up to 132 access points. Suprema modules provides secure connection with encrypted communication.

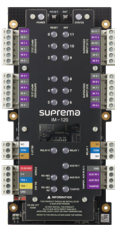

### Input Module (IM-120)

- 12 supervised inputs
- Offline operation
- Auxiliary & tamper input



### Output Module (OM-120)

- Up to 12 output relays
- Elevator control with BioStar 2
- Anti-passback, fire alarm feature



### Secure Module (SIO2)

- Secure door control
- Encrypted communication
- Compact form factor

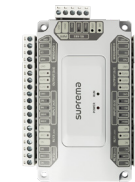

### Door Module (DM-20)

- Up to 4 doors
- Encrypted communication
- Two Wiegand interfaces



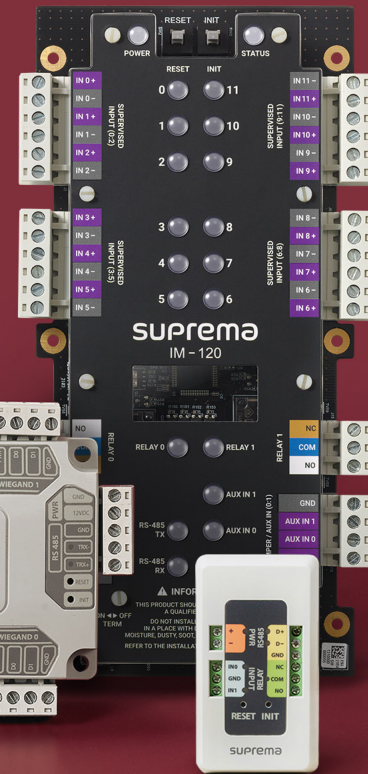
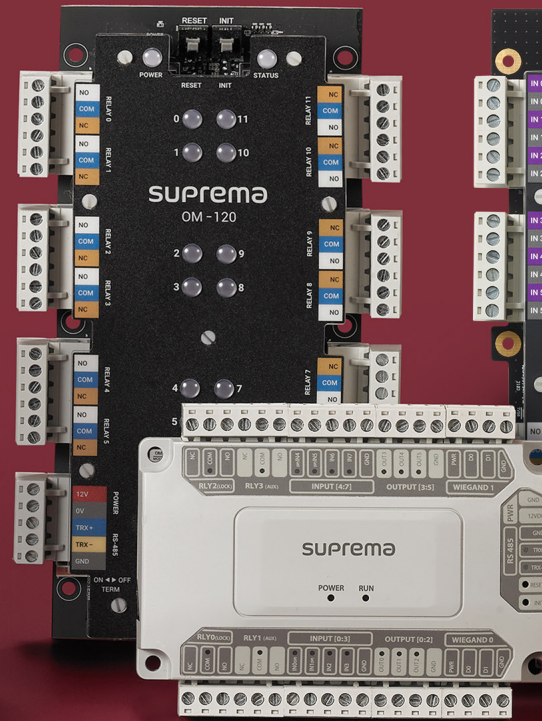

BookCafe

# RFID Reader

Suprema offers card readers that support dual-frequency RFID technology, compatible with a wide range of card types including MIFARE, DESFire, FeliCa and EM. Suprema card readers can also read mobile credentials using both NFC and BLE communication. Suprema X-Station 2 is equipped with color LCD touchscreen and QR code recognition and can be used to manage time and attendance as well as visitor passage and access control at unmanned facilities.





### X-Station 2 | Versatile Intelligent Terminal

- Compatible with most RFID cards, Mobile Access cards, QR codes
- Enhanced security with Secure Boot and OSDP(Open Supervised Device Protocol)
- Built-in Camera for image logs



### XPass 2 | Outdoor Compact RFID Device

- Compatible with most RFID cards and dual-frequency
- Mobile Access cards
- IP67 and IK08 Vandal-proof structure



### XPass D2 | Outdoor Compact RFID Reader

- Compatible with most RFID cards and dual-frequency
- Mobile Access cards\*
- IP67 and IK08 Vandal-proof structure
- SIA OSDP verified

\* Suprema Mobile Access is supported on XPass D2 - V02A H/W versions only.

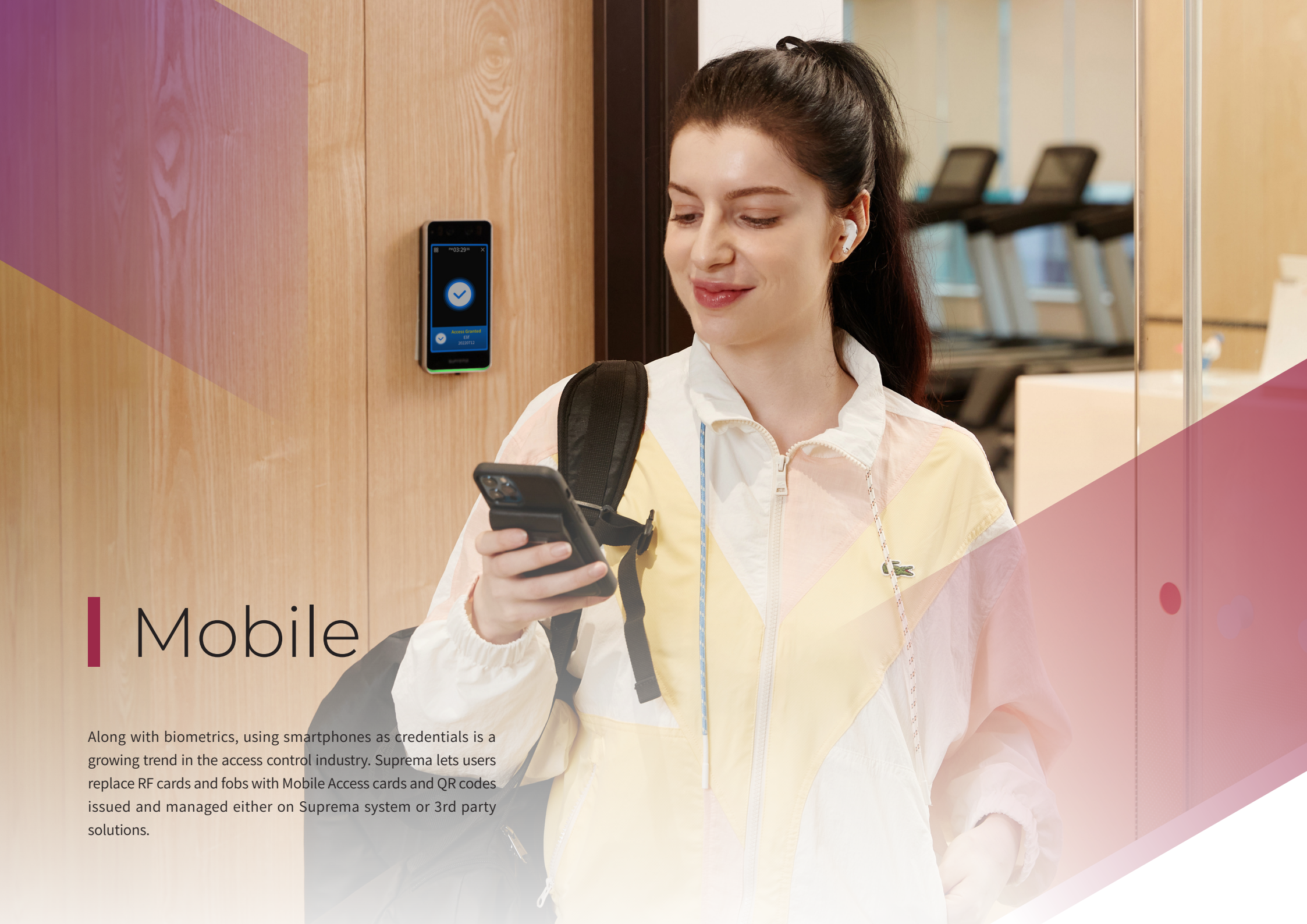

# Mobile

Along with biometrics, using smartphones as credentials is a growing trend in the access control industry. Suprema lets users replace RF cards and fobs with Mobile Access cards and QR codes issued and managed either on Suprema system or 3rd party solutions.

# Suprema Mobile Access

Suprema Mobile Access significantly improves user convenience by letting people use smartphones as access cards. Mobile access cards can be issued on either BioStar 2 or Suprema Airfob Portal and users can receive them via email. Suprema Mobile Access can easily be integrated with 3rd party systems.



- 

Fast and easy contactless solution
- 

Support both NFC & BLE (Bluetooth 4.2 or above)
- 

Remote management via web portal
- 

Background mode (BLE, Standby mode)
- 

Compatible with Android (9.0 or above) & iOS (7.0 or above)

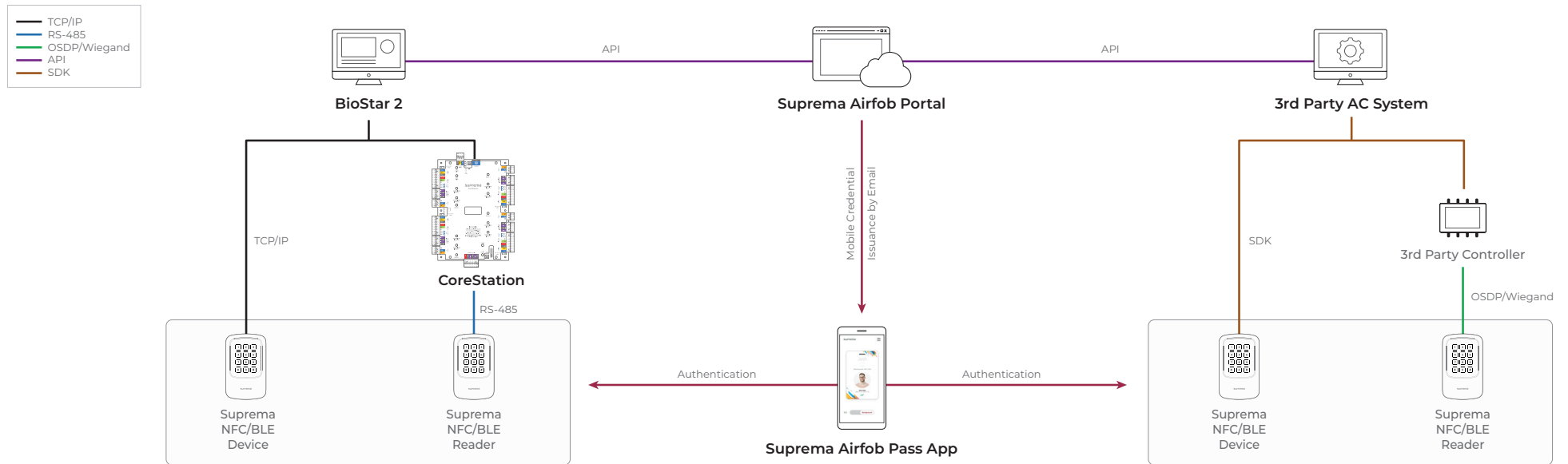



## QR Code

Suprema offers the option of using QR codes as credential. Suprema's BioStation 3 and X-Station 2 can read QR codes composed of up to 32 ASCII codes. QR codes can be issued on BioStar 2 or 3rd party systems.

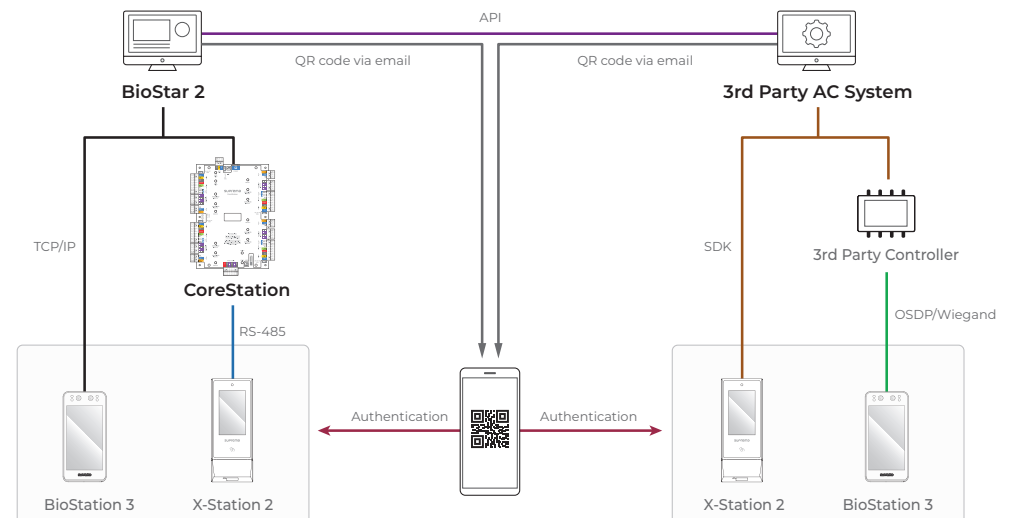





# Biometrics

Leading provider of biometric solutions since 2000, Suprema has continuously innovated fingerprint and facial authentication technology as well as deep learning artificial intelligence that is core to biometric solutions.



# Artificial Intelligence

Leveraging Suprema's extensive field data accumulated for over decades, Suprema boasts unparalleled authentication capabilities specializing in biometric access control. Suprema has developed a cutting-edge biometric authentication AI algorithm, adopting a highly advanced AI processor known as the NPU (Neural Processing Unit), optimized for deep learning. With its expertise in creating a lightweight AI engine and capability to effectively train vast biometric template data, Suprema's deep-learning based AI algorithm ensures the highest accuracy in authentication performance. This positioned Suprema as the world's first company to adopt NPU-based deep-learning technology into biometric authentication.

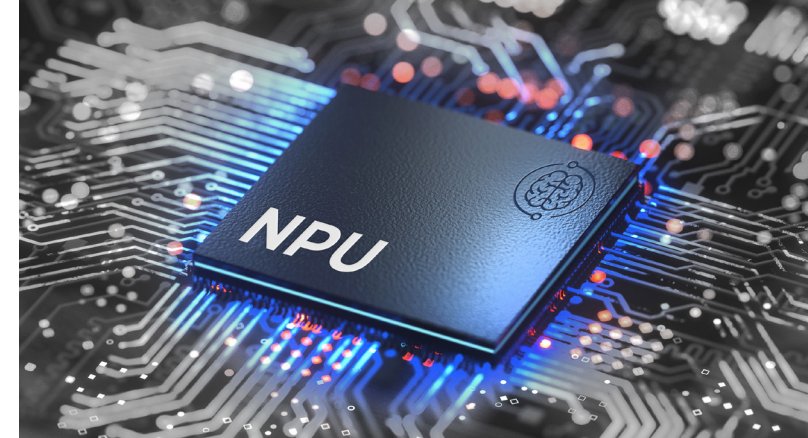

# Facial Authentication

Suprema's deep-learning based AI algorithm delivers highly accurate and fast facial authentication performance with BioStation 3. It uses dynamic face templates to increase matching accuracy for people of diverse ethnicities and those wearing masks, glasses, hats, beards, niqabs, and various hairstyles. Also, it is not only highly accurate but also fast, so it takes within 0.2 seconds to authenticate moving faces.

# Fingerprint Recognition

Suprema has pioneered fingerprint recognition technology based on deep learning. As a result, the accuracy, speed, and spoof-fingerprint detection performance of BioStation 2a's deep-learning-based AI algorithm are outstanding. Deep-learning has significantly enhanced the AI algorithm's capability to extract templates from low-quality fingerprints, such as those that are noisy or distorted. Also, it offers Live Finger Detection (LFD) which detects fake fingerprints copied using rubber, silicone, clay, glue, film, etc. ensuring highly accurate performance.



# Fingerprint Modules - SFM Series

The World's Best-Performing Embedded Fingerprint Modules  
For self-service kiosks and other management solutions.

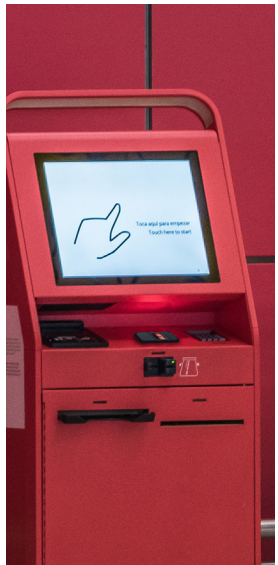
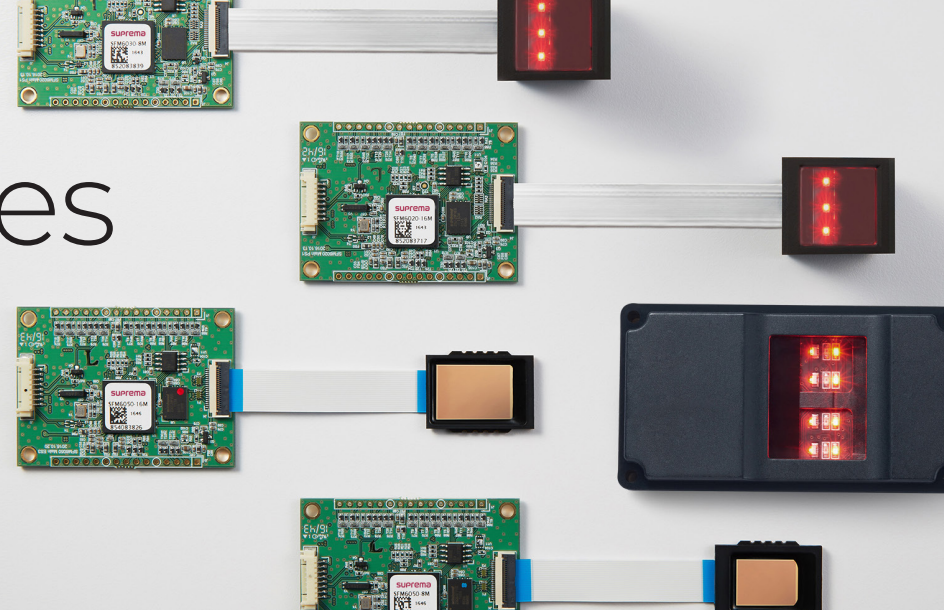

Membership Management Kiosks



Cabinet Management Solutions



Interstate Trucking and Special Purpose Vehicle Attendance



Electronic Voting System



Cash Exchange Machine



Vending Machine



Medical Equipment

# Development Tools

Suprema is integrating with security system partners to be able to offer our products and solutions to a wider group of customers. Integration lets customers add Suprema products to their infrastructure in a streamlined and efficient way.

## BioStar 2 API

BioStar 2 API is a Web API that enables integration between BioStar 2 and 3rd party softwares. BioStar 2 API are standardized and allows communication using REST and JSON, making integration and app development easy.

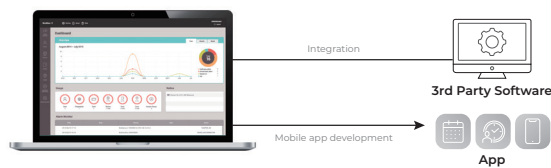

## Suprema G-SDK

Suprema G-SDK is a highly-scalable development kit that enables device management for multi-site, multi-tenant customers. It is mobile and cloud-friendly, allowing you to easily add and manage devices via Device Gateways when a new site is added. Based on gRPC, Suprema G-SDK supports many programming languages including Java, C#, Python, Node.js, Go, and C++.

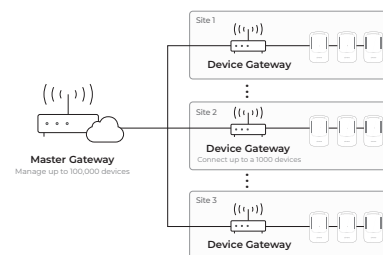

## BioStar 2 Device SDK



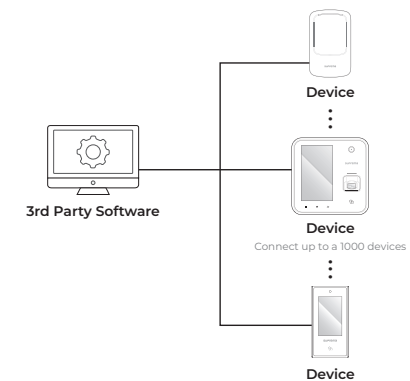



BioStar 2 Device SDK is a development tool that enables you to control the core features of Suprema's terminal through 3rd party software.



Product						
Product Name		FaceStation F2	BioStation 3	FaceStation 2	BioStation 2a	BioStation L2
General	Biometric	Face: FSF2-DB, AB / Face, Fingerprint: FSF2-ODB	Face	Face	Fingerprint	Fingerprint
	LFD (Live Finger Detection)	FSF2-DB, AB: - / FSF2-ODB: Supported (SW-based)	-	-	Supported (SW-based)	Supported
	Protection Class	IP65	IP65, IK06	-	IP65	-
	RF Options	<b>FSF2-DB:</b> 125kHz EM & 13.56MHz MIFARE, MIFARE Plus, DESFire, DESFire EV1/EV2/EV3 <sup>(1)</sup> , FeliCa <b>FSF2-AB:</b> 125kHz EM, HID Prox & 13.56MHz MIFARE, MIFARE Plus, DESFire, DESFire EV1/EV2/EV3 <sup>(1)</sup> , FeliCa, iCLASS SE/SR/Seos <b>FSF2-ODB:</b> 125kHz EM & 13.56MHz MIFARE, MIFARE Plus, DESFire, DESFire EV1/EV2/EV3 <sup>(1)</sup> , FeliCa	<b>BS3-DB:</b> 125kHz EM & 13.56MHz MIFARE, MIFARE Plus, DESFire, DESFire EV1/EV2/EV3 <sup>(1)</sup> , FeliCa <b>BS3-APWB:</b> 125kHz EM, HID Prox & 13.56MHz MIFARE, MIFARE Plus, DESFire, DESFire EV1/EV2/EV3 <sup>(1)</sup> , FeliCa, iCLASS SE/SR/Seos	<b>FS2-D:</b> 125kHz EM & 13.56MHz MIFARE, MIFARE Plus, DESFire, DESFire EV1/EV2/EV3 <sup>(1)</sup> , FeliCa <b>FS2-AWB:</b> 125kHz EM, HID Prox & 13.56MHz MIFARE, MIFARE Plus, DESFire, DESFire EV1/EV2/EV3 <sup>(1)</sup> , FeliCa, iCLASS SE/SR/Seos	<b>BS2A-ODPB:</b> 125kHz EM & 13.56MHz MIFARE, MIFARE Plus, DESFire, DESFire EV1/EV2/EV3 <sup>(1)</sup> , FeliCa <b>BS2A-OAPWB:</b> 125kHz EM, HID Prox & 13.56MHz MIFARE, MIFARE Plus, DESFire, DESFire EV1/EV2/EV3 <sup>(1)</sup> , iCLASS SE/SR/Seos, FeliCa	<b>BSL2-OE:</b> 125kHz EM <b>BSL2-OM:</b> 13.56 MHz MIFARE, MIFARE Plus, DESFire, DESFire EV1/EV2/EV3 <sup>(1)</sup> , FeliCa
	Mobile	NFC, BLE	NFC, BLE	<b>FS2-D:</b> NFC <b>FS2-AWB:</b> NFC, BLE	NFC, BLE	<b>BSL2-OE:</b> - <b>BSL2-OM:</b> NFC
Capacity	Max. User <sup>(1)</sup>	100,000	100,000	30,000	500,000	500,000
	Max. Credential (1:N) <sup>(4)</sup>	Face: 50,000 Fingerprint: 100,000	Face: 50,000	Face: 4,000	Fingerprint: 100,000	Fingerprint: 100,000
	Max. Credential (1:1) <sup>(4)</sup>	Face: 100,000 Fingerprint: 100,000 Card: 100,000 PIN: 100,000	Face: 100,000 Card: 100,000 PIN: 100,000	Face: 30,000 Card: 30,000 PIN: 30,000	Fingerprint: 500,000 Card: 500,000 PIN: 500,000	Fingerprint: 500,000 Card: 500,000 PIN: 500,000
	Max. Text Logs	5,000,000	5,000,000	5,000,000	5,000,000	1,000,000
	Max. Image Logs	50,000	50,000	50,000	-	-
Interfaces	Wi-Fi	-	<b>BS3-DB:</b> - / <b>BS3-APWB:</b> 802.11 b/g/n 2.4 GHz	<b>FS2-D:</b> - / <b>FS2-AWB:</b> Built-in, IEEE 802.11 b/g	<b>BS2A-ODPB:</b> - / <b>BS2A-OAPWB:</b> 802.11 b/g/n 2.4 GHz	-
	Ethernet	10/100 Mbps, auto MDI/MDI-X	10/100/1000 Mbps, auto MDI/MDI-X	10/100/1000 Mbps, auto MDI/MDI-X	10/100 Mbps, auto MDI/MDI-X	10/100 Mbps, auto MDI/MDI-X
	RS-485	1 ch Master or Slave (Selectable)	1 ch Master or Slave (Selectable)	1 ch Master or Slave (Selectable)	1 ch Master or Slave (Selectable)	1 ch Master or Slave (Selectable)
	RS-485 Communication Protocol	OSDP V2 compliant	OSDP V2 compliant	OSDP V2 compliant	OSDP V2 compliant	OSDP V2 compliant
	Wiegand	1 ch Input or 1 ch Output (Selectable)	1 ch Input and 1 ch Output	1 ch Input and 1 ch Output	1 ch Input and 1 ch Output	1 ch Input or Output (Selectable)
	TTL Input	2 ch Input	3 ch Input	2 ch Input	3 ch Input	2 ch Input
	Relay	1 Relay	1 Relay	1 Relay	1 Relay	1 Relay
	USB	USB 2.0 (Host)	USB 2.0 (Host)	USB 2.0 (Host)	USB 2.0 (Host)	-
Hardware	CPU	1.8 GHz Dual Core + 1.4 GHz Quad Core	1.5 GHz Quad Core	1.4 GHz Quad Core	1.5 GHz Quad Core	1.2 GHz Quad Core
	Memory	16 GB Flash + 2 GB RAM	32 GB Flash + 4 GB RAM	8 GB Flash + 1 GB RAM	16 GB Flash + 2 GB RAM	2 GB Flash + 256 MB RAM
	Crypto Chip	Supported	Supported	Supported	Supported	Supported
	Sound	16 bit	16 bit	24 bit Voice DSP (echo cancellation)	16 bit	16 bit
	Operating Temperature	-20°C ~ 50°C (-4°F ~ 122°F)	-20°C ~ 50°C (-4°F ~ 122°F)	-20°C ~ 50°C (-4°F ~ 122°F)	-20°C ~ 60°C (-4°F ~ 140°F)	-20°C ~ 50°C (-4°F ~ 122°F)
	Tamper	Supported	Supported	Supported	Supported	Supported
	Power	Voltage: 12 Vdc, Current: Max. 2.1 A Voltage: 24 Vdc, Current: Max. 1 A	Voltage: 12 Vdc, Current: Max. 1 A Voltage: 24 Vdc, Current: Max. 0.65 A	Voltage: 24 Vdc, Current: Max. 1.2 A	Voltage: 12 Vdc, Current: Max. 0.8 A Voltage: 24 Vdc, Current: Max. 0.4 A	Voltage: 12 Vdc, Current: Max. 0.5 A
	PoE	-	<b>BS3-DB:</b> - <b>BS3-APWB:</b> IEEE 802.3at compliant	-	IEEE 802.3af compliant	-
	Dimensions (W x H x D mm)	<b>FSF2-DB, AB:</b> 119.8 x 233 x 23.5 <b>FSF2-ODB:</b> 119.8 x 268.3 x 49.6	82.5 x 171 x 23.4	140.9 x 197.5 x 86.2	142 x 144 x 45 (Bottom) / 37.8 (Top)	70.9 x 200.9 x 44.3 (Bottom) / 34.2 (Top)
Certifications	CE, UKCA, KC, FCC, IC, RCM, BIS, ANATEL, SIG, RoHS, REACH, WEEE	<b>BS3-DB:</b> CE, UKCA, KC, FCC, IC, RCM, BIS, SIG, RoHS, REACH, WEEE, MIC, TELEC <b>BS3-APWB:</b> CE, UKCA, KC, FCC, IC, RCM, BIS, SIG, RoHS, REACH, WEEE, MIC, TELEC, ETL Listed to UL 294	CE, UKCA, KC, FCC, IC, RCM, BIS, SIG, RoHS, REACH, WEEE	CE, UKCA, KC, FCC, RCM, SIG, RoHS, REACH, WEEE	CE, UKCA, KC, FCC, BIS, RoHS, REACH, WEEE	

(1) The number of users registered without having any credential data. (2) DESFire EV2 cards are supported by having backward compatibility of DESFire EV1 cards. CSN and smart card functions are compatible with Suprema devices.

(3) DESFire EV2/EV3 cards are supported by having backward compatibility of DESFire EV1 cards. CSN and smart card functions are compatible with Suprema devices.  
(4) If FaceStation F2, BioStation 3 and FaceStation 2 are a master device and a device with a fingerprint sensor is connected as a slave, the slave device can be used for fingerprint authentication. You can find the capacity for fingerprint in the website's guide documentation.





					
BioLite N2	BioEntry W2 <sup>(5)</sup>	BioEntry P2	X-Station 2	XPass 2	XPass S2
Fingerprint	Fingerprint	Fingerprint	Fingerprint: XS2-ODPB, OAPB	-	-
Supported (SW-based)	Supported (HW + SW-based)	Supported (SW-based)	<b>XS2-ODPB, OAPB:</b> Supported (SW-based)	-	-
IP67	IP67, IK09	-	IP65	IP65, IP67, IK08	IP65
<b>BLN2-ODB:</b> 125kHz EM & 13.56MHz MIFARE, MIFARE Plus, DESFire, DESFire EV1/EV2/EV3 <sup>®</sup> , FeliCa <b>BLN2-OAB, PAB:</b> 125kHz EM, HID Prox & 13.56MHz MIFARE, MIFARE Plus, DESFire, DESFire EV1/EV2/EV3 <sup>®</sup> , FeliCa, iCLASS SE/SR/Seos	<b>BEW2-OHPB:</b> 125kHz EM, HID Prox & 13.56MHz MIFARE, MIFARE Plus, DESFire, DESFire EV1/EV2/EV3 <sup>®</sup> , FeliCa <b>BEW2-ODPB:</b> 125kHz EM & 13.56MHz MIFARE, MIFARE Plus, DESFire, DESFire EV1/EV2/EV3 <sup>®</sup> , FeliCa <b>BEW2-OAPB:</b> 125kHz EM, HID Prox & 13.56MHz MIFARE, MIFARE Plus, DESFire, DESFire EV1/EV2/EV3 <sup>®</sup> , FeliCa, iCLASS SE/SR/Seos	<b>BEP2-OD:</b> 125KHz EM & 13.56MHz MIFARE, MIFARE Plus, DESFire, DESFire EV1/EV2/EV3 <sup>®</sup> , FeliCa <b>BEP2-OA:</b> 125KHz EM, HID Prox & 13.56MHz MIFARE, MIFARE Plus, DESFire, DESFire EV1/EV2/EV3 <sup>®</sup> , FeliCa, iCLASS SE/SR/Seos	<b>XS2-ODPB, QDPB, DPB:</b> 125 kHz EM & 13.56 MHz MIFARE, MIFARE Plus, DESFire, DESFire EV1/EV2/EV3 <sup>®</sup> , FeliCa <b>XS2-OAPB, QAPB, APB:</b> 125 kHz EM, HID Prox & 13.56 MHz MIFARE, MIFARE Plus, DESFire, DESFire EV1/EV2/EV3 <sup>®</sup> , FeliCa, iCLASS SE/SR/Seos	<b>XP2-MDPB, GDPB, GKDPB:</b> 125 kHz EM & 13.56 MHz MIFARE, MIFARE Plus, DESFire, DESFire EV1/EV2/EV3 <sup>®</sup> , FeliCa <b>XP2-MAPB:</b> 125 kHz EM, HID Prox & 13.56 MHz MIFARE, MIFARE Plus, DESFire, DESFire EV1/EV2/EV3 <sup>®</sup> , FeliCa, iCLASS SE/SR/Seos	13.56MHz MIFARE, MIFARE Plus, DESFire/EV1 (CSN), FeliCa, ISO14443A, ISO15693
NFC, BLE	NFC, BLE	NFC	NFC, BLE	NFC, BLE	-
10,000	500,000	10,000	500,000	200,000	50,000
Fingerprint: 10,000	Fingerprint: 100,000	Fingerprint: 10,000	Fingerprint: 100,000 ( <b>XS2-ODPB, OAPB</b> only)	-	-
Fingerprint: 10,000 Card: 10,000 PIN: 10,000	Fingerprint: 500,000 Card: 500,000	Fingerprint: 10,000 Card: 10,000	Fingerprint: 500,000 ( <b>XS2-ODPB, OAPB</b> only) Card: 500,000 PIN: 500,000	Card: 200,000 PIN: 200,000	Card: 50,000
1,000,000	1,000,000	1,000,000	5,000,000	1,000,000	100,000
-	-	-	50,000	-	-
-	-	-	-	-	-
10/100 Mbps, auto MDI/MDI-X	10/100 Mbps, auto MDI/MDI-X	10/100 Mbps, auto MDI/MDI-X	10/100 Mbps, auto MDI/MDI-X	10/100 Mbps, auto MDI/MDI-X	10/100 Mbps, auto MDI/MDI-X
1 ch Master or Slave (Selectable)	1 ch Master or Slave (Selectable)	1 ch Master or Slave (Selectable)	1 ch Master or Slave (Selectable)	1 ch Master or Slave (Selectable)	1 ch Master or Slave (Selectable)
OSDP V2 compliant	OSDP V2 compliant	OSDP V2 compliant	OSDP V2 compliant	OSDP V2 compliant	OSDP V2 compliant
1 ch Input or Output (Selectable)	1 ch Input or Output (Selectable)	1 ch Input or Output (Selectable)	1 ch Input or Output (Selectable)	1 ch Input or Output (Selectable)	1 ch Input or Output (Selectable)
2 ch Input	2 ch Input	2 ch Input	2 ch Input	2 ch Input	2 ch Input
1 Relay	1 Relay	1 Relay	1 Relay	1 Relay	1 Relay
-	-	-	USB 2.0 (Host)	-	-
1.2 GHz	1.2 GHz Quad Core	1.0 GHz	1.5 GHz Quad Core	1.0 GHz	533 MHz DSP
4 GB Flash + 64 MB RAM	2 GB Flash + 256 MB RAM	8 GB Flash + 64 MB RAM	16 GB Flash + 1 GB RAM	4 GB Flash + 64 MB RAM	16 MB Flash + 16 MB RAM
Supported	Supported	Supported	Supported	Supported	Supported
16 bit	Multi-tone Buzzer	Multi-tone Buzzer	24 bit	Multi-tone Buzzer	Multi-tone Buzzer
<b>BLN2-ODB, OAB:</b> -20°C ~ 50°C (-4°F ~ 122°F) <b>BLN2-PAB:</b> -10°C ~ 50°C (14°F ~ 122°F)	-20°C ~ 50°C (-4°F ~ 122°F)	-20°C ~ 50°C (-4°F ~ 122°F)	-20°C ~ 50°C (-4°F ~ 122°F)	-35°C ~ 65°C (-31°F ~ 149°F)	-35°C ~ 65°C (-31°F ~ 149°F)
Supported	Supported	Supported	Supported	Supported	Supported
Voltage: 12 Vdc, Current: Max. 0.4 A	Voltage: 12 Vdc, Current: Max. 0.5 A	Voltage: 12 Vdc, Current: Max. 0.2 A	Voltage: 12 Vdc, Current: Max. 0.8 A Voltage: 24 Vdc, Current: Max. 0.5 A	Voltage: 12 Vdc, Current: Max. 0.5 A Voltage: 24 Vdc, Current: Max. 0.3 A	Voltage: 12 Vdc, Current: Max. 0.4 A
-	IEEE 802.3af compliant	-	IEEE 802.3af compliant	IEEE 802.3af compliant	-
58 x 190 x 44 (Bottom) / 34.6 (Top)	50 x 172 x 43.4 (Bottom) / 38.1 (Top)	50.1 x 164 x 38	<b>XS2-ODPB, OAPB:</b> 82 x 208.5 x 53 (Bottom) / 25.9 (Top) <b>XS2-QDPB, QAPB:</b> 82 x 203 x 33.9 <b>XS2-DPB, APB:</b> 82 x 159 x 25.9	<b>XP2-MDPB, MAPB:</b> 48 x 144.7 x 27 <b>XP2-GDPB, GKDPB:</b> 80 x 130 x 25	80 x 120 x 11.4
CE, UKCA, KC, FCC, IC, RCM, BIS, SIG, RoHS, REACH, WEEE	<b>BEW2-OHPB, ODPB:</b> CE, UKCA, KC, FCC, IC, RCM, BIS, ANATEL, SIG, RoHS, REACH, WEEE <b>BEW2-OAPB:</b> CE, UKCA, KC, FCC, IC, RCM, BIS, ANATEL, SIG, RoHS, REACH, WEEE, ETL Listed to UL 294	CE, UKCA, KC, FCC, RCM, BIS, ANATEL, RoHS, REACH, WEEE	<b>XS2-ODPB, OAPB:</b> CE, UKCA, KC, FCC, IC, RCM, BIS, ANATEL, SIG, RoHS, REACH, WEEE <b>XS2-DPB, QDPB:</b> CE, UKCA, KC, FCC, IC, RCM, BIS, ANATEL, SIG, TELECOM, RoHS, REACH, WEEE	<b>XP2-MDPB, GDPB:</b> CE, UKCA, KC, FCC, IC, RCM, BIS, SIG, RoHS, REACH, WEEE, ETL Listed to UL 294 <b>XP2-GKDPB:</b> CE, UKCA, KC, FCC, IC, RCM, BIS, SIG, TELECOM, RoHS, REACH, WEEE, ETL Listed to UL 294 <b>XP2-MAPB:</b> CE, UKCA, KC, FCC, RCM, BIS, SIG, RoHS, REACH, WEEE	CE, UKCA, KC, FCC, BIS, RoHS, REACH, WEEE

(5) Some models (BEW2-ODP, BEW2-OAP, BEW2-OHP) do not support BLE.



Product		
Product Name		<b>CoreStation (CS-40)</b>
Capacity	Max. User	500,000
	Max. Credential (1:N)	Face: 4,000 Fingerprint: 100,000 <sup>(6)</sup>
	Max. Credential (1:1)	Face: 30,000 Fingerprint: 500,000 <sup>(6)</sup> Card: 500,000 PIN: 500,000
	Max. Text Logs	5,000,000
Interfaces	Ethernet	10/100 Mbps, Auto MDI/MDI-X
	RS-485	5 ch
	RS-485 Communication Protocol	OSDP V2 compliant
	Wiegand	4 ch
	Relay	4 Relays
	Supervised Input	8 ch (TTL Input Selectable)
	TTL Output	8 ch
	AUX Input	2 ch (AC Power Fail, Tamper)
Connectivity	Max. Slave Devices (RS-485)	Max. 64 devices (Max. 31 devices per port)
	Max. Wiegand Devices	Max. 132 devices (with DM-20)
Hardware	CPU	1.4 GHz Octa Core
	Memory	8 GB Flash + 1 GB RAM
	Crypto Chip	Supported
	LED	Multi-color
	Operating Temperature	0°C ~ 50°C (32°F ~ 122°F)
	Tamper	Optional (ENCR-10)
	Power	Voltage: 12 Vdc, Current: Max. 0.2 A Voltage: 24 Vdc, Current: Max. 0.1 A
	Dimensions (W x H x D mm)	150 x 214 x 21
Certifications	CE, UKCA, KC, FCC, RCM, RoHS, REACH, WEEE, ETL Listed to UL 294	

Product			
Product Name		<b>BioEntry R2</b>	<b>XPass D2</b>
General	Biometrics	Fingerprint	-
	Protection Class	-	IP65, IP67, IK08
	RF Options	<b>BER2-OD:</b> 125kHz EM & 13.56MHz MIFARE, MIFARE Plus, DESFire EV1/EV2/EV3 <sup>(7)</sup> , FeliCa	<b>XPD2-MDB, GDB, GKDB:</b> 125kHz EM & 13.56MHz MIFARE, MIFARE Plus, DESFire, DESFire EV1/EV2/EV3 <sup>(7)</sup> , FeliCa
	Mobile	<b>BER2-OD:</b> NFC	<b>XPD2-MDB, GDB, GKDB:</b> NFC, BLE
Interfaces	RS-485	1 ch Slave	1 ch
	RS-485 Communication Protocol	OSDP V2 compliant	OSDP V2 compliant
	Wiegand	-	1 ch
Hardware	CPU	1.0 GHz	80 MHz
	Memory	32 MB Flash + 32 MB RAM	512 KB Flash + 160 KB RAM
	Sound	Multi-tone Buzzer	Multi-tone Buzzer
	Operating Temperature	-20°C ~ 50°C (-4°F ~ 122°F)	-35°C ~ 65°C (-31°F ~ 149°F)
	Tamper	Supported	Supported
	Power	Voltage: 12 Vdc, Current: Max. 0.2 A	Voltage: 12 Vdc, Current: Max. 0.3 A
	Dimensions (W x H x D mm)	50.1 x 164 x 38	<b>XPD2-MDB:</b> 48 x 144.7 x 27 <b>XPD2-GDB, GKDB:</b> 80 x 130 x 25
	Certifications	CE, UKCA, KC, FCC, RoHS, REACH, WEEE	CE, UKCA, KC, FCC, IC, RCM, BIS, SIG, RoHS, REACH, WEEE, ETL Listed to UL 294

Product					
Product Name		<b>Input Module (IM-120)</b>	<b>Output Module (OM-120)</b>	<b>Door Module (DM-20)</b>	<b>Secure Module (Secure I/O 2)</b>
Interfaces	RS-485	1 ch	1 ch	1 ch	1 ch
	RS-485 Communication Protocol	OSDP V2 compliant	OSDP V2 compliant	OSDP V2 compliant	OSDP V2 compliant
	Wiegand	-	-	2 ch	-
	Relay	2 Relays	12 Relays	4 Relays	1 Relay
	Input	Supervised Input: 12 ch (TTL Input Selectable)	-	TTL Input: 4 ch Supervised Input: 4 ch	TTL Input: 2 ch
	Output	-	-	TTL Output: 6 ch	-
Hardware	AUX Input	2 ch (AC POWER FAIL)	2 ch Dry Contact Input	-	-
	CPU	Cortex M3 72MHz	Cortex M3 72MHz	Cortex M3 72MHz	Cortex M3 72MHz
	Memory	512 KB Flash + 64 KB SRAM	128 KB Flash + 20 KB SRAM	128 KB Flash + 20 KB SRAM	128 KB Flash + 20 KB RAM
	LED	Multi-color	Multi-color	Multi-color	Multi-color
	Operating Temperature	-20°C ~ 60°C (-4°F ~ 140°F)	-20°C ~ 60°C (-4°F ~ 140°F)	-20°C ~ 60°C (-4°F ~ 140°F)	-20°C ~ 50°C (-4°F ~ 122°F)
	Power	Voltage: 12 Vdc, Current: Max. 0.2 A	Voltage: 12 Vdc, Current: Max. 0.6 A	Voltage: 12 Vdc, Current: Max. 3.1 A	Voltage: 12 Vdc, Current: Max. 0.5 A
	Dimensions (W x H x D mm)	90 x 190 x 21	90 x 190 x 21	130 x 90.5 x 35.8	36 x 65 x 18
	Certifications	CE, UKCA, KC, FCC, RCM, RoHS, REACH, WEEE	CE, UKCA, KC, FCC, RoHS, REACH, WEEE	CE, UKCA, KC, FCC, RoHS, REACH, WEEE	CE, UKCA, KC, FCC, RoHS, REACH, WEEE, ETL Listed to UL 294

(6) If a device with a fingerprint sensor is connected as a slave, the slave device can be used for fingerprint authentication. (7) DESFire EV2/EV3 cards are supported by having backward compatibility of DESFire EV1 cards. CSN and smart card functions are compatible with Suprema devices.



**Suprema Inc.**

17F Parkview Tower, 248, Jeongjail-ro, Bundang- gu, Seongnam-si, Gyeonggi-do, 13554, Republic of Korea

T +82 31 783 4502    www.supremainc.com



For more information, visit our website below by scanning the QR code.  
<https://www.supremainc.com/en/about/contact-us.asp>

©2024 Suprema Inc. Suprema and identifying product names and numbers herein are registered trademarks of Suprema, Inc. All non-Suprema brands and product names are trademarks or registered trademarks of their respective companies. Product appearance, build status and/or specifications are subject to change without notice. [SUPREMA-AMB-LB-EN-REV46]